



Antenna installation

When selecting an antenna, consider radio proximity.

Use Figure 1 as a guide for installing an antenna and attaching it to the 925U-2-XXX.

Figure 1. Antenna installation

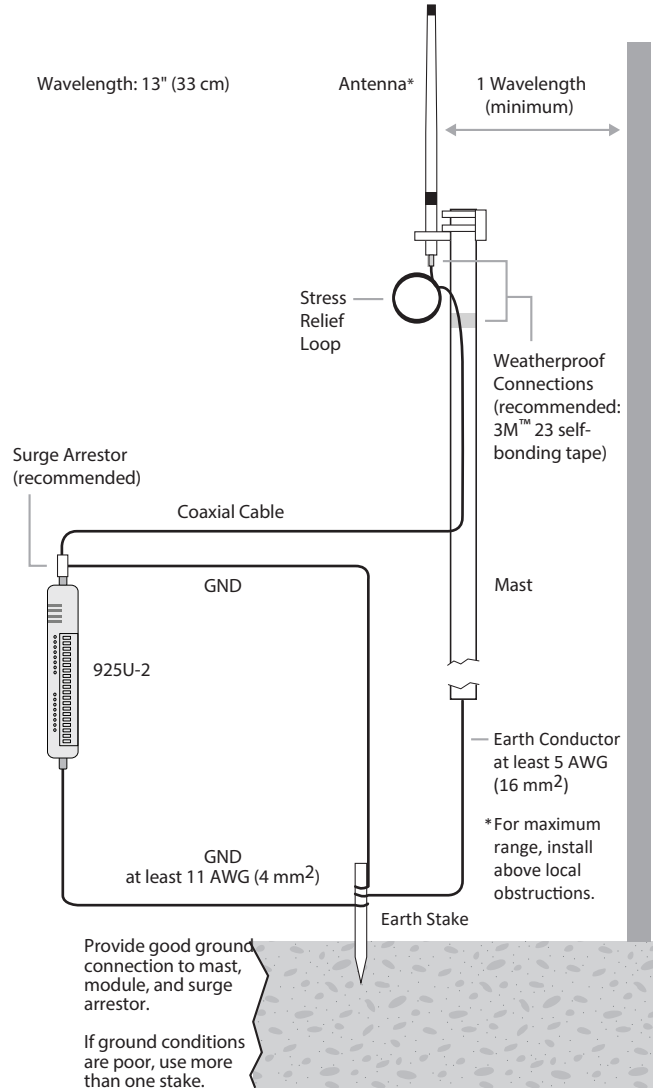

STATUTORY REQUIRMENTS

FCC: This device complies with Part 15.247 of the FCC Rules. Operation is subject to the following two conditions:

- This device may not cause harmful interference.
- This device must accept any interference received, including interference that may cause undesired operation.

FCC: Unlicensed operation limits the radio power. High gain aerials may only be used to compensate for cable losses.

WARNING - EXPLOSION HAZARD

Do not disconnect the device while the circuit is live unless the area is known to be non-hazardous.

NOTE

The 925U-2 module ships from the factory as a bridged meshing radio.

All connections must be SELV <50 Vac and <60Vdc
If communication with the older legacy 915U-2's is required, radio operating mode can be changed with a firmware downgrade, which is available on the USB Stick in the box. Please follow the "Downgrade procedure" document which is also on the USB.

Models

925U-2-869 – 869.5 to 969.9MHz - 869 MHz ISM band (Europe)

925U-2-900 – 902 to 928MHz - 900Mhz FHSS band

Connecting to the module for configuration

- Download and install configuration utility software, available from the Elpro Technologies website. www.elprotech.com
- Connect to PC using supplied USB cable.
- Connect to the device by selecting USB connection and using the IP address 192.168.111.1 or 1.1.1 for older firmware (pre V2.28)
- The PC will automatically be assigned an IP address from the module via DHCP. A new network adaptor will be created using IP address 192.168.1.2 (or 1.1.1.2)
- **Username:** user
- **Password:** user

The following illustrations show the port connections on the 925U-2-XXX.

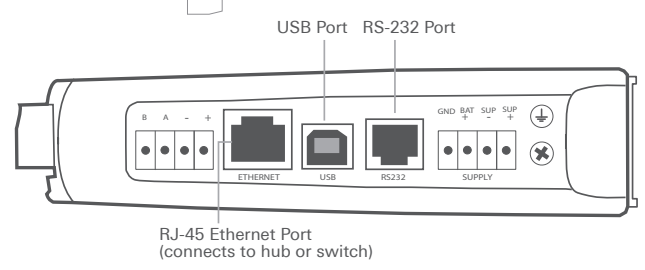
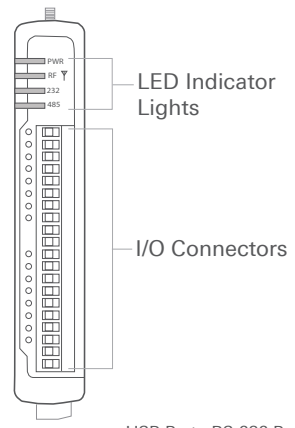

Power Supply Wiring

The ground (GND) and "SUP -" terminals are connected internally to the ground (Earth) terminal. Connect the screw terminal on the end plate to ground (Earth) for surge protection.

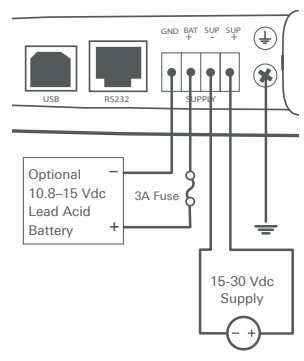

Expansion I/O Power and RS485 serial connection

An on-board RS-485 terminating resistor provides line termination for long runs. Only enable terminating resistor on the last device connected on the RS-485 cable.

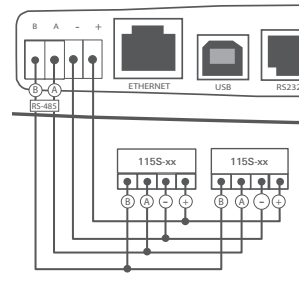

Configuration Switches

Use the DIP switches in the side access panel to select analog input voltage or current, and to enable default configuration.

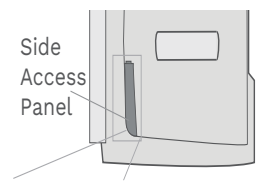

DIP	Description	OFF	ON
1	AI3 Current / Voltage	Voltage	Current
2	AI3 Current / Voltage	Voltage	Current
3	AI4 Current / Voltage	Voltage	Current
4	AI4 Current / Voltage	Voltage	Current
5	Unused	Off	On
6	Default configuration	Normal	Enabled

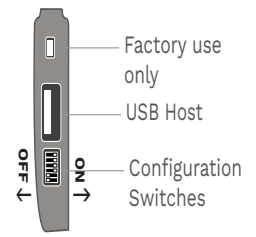

Input and Output connections

The digital input/output channels can be wired as inputs or outputs.

Digital Input

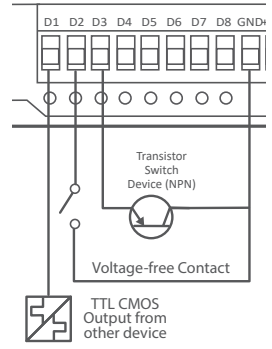

Digital Output

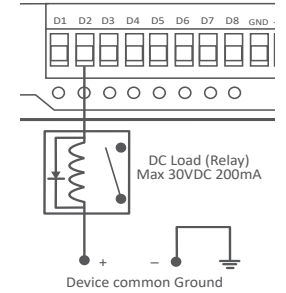

AI1, AI2 - Differential 4-20mA inputs

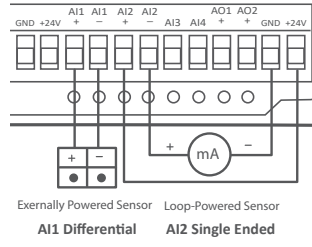

AI3, AI4 - Single Ended 4-20mA inputs

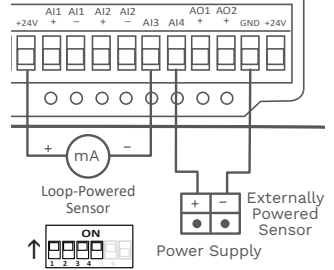

AO1 & AO2 - Analog Output (0-20mA)

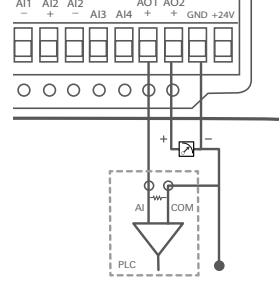

AI3 & AI4 - Single Ended voltage input

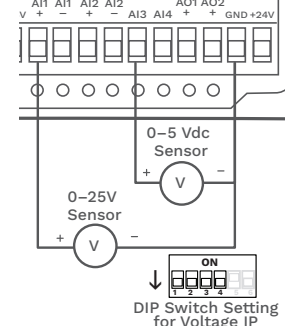

CONTACT

Australia
ELPRO Technologies
29 Lathe Street
Virginia QLD 4014
T +61 7 3352 8600
E sales@elprotech.com
W elprotech.com

USA
ELPRO Technologies Inc
2028 East Ben White Boulevard
#240-5656 Austin, TX 78741-6931
T +1 855 443 5776
E sales@elprotech.com
W elprotech.com

HOW TO ORDER

Simply send us an email at sales@elprotech.com, contact your local distributor, or phone **+61 7 3352 8600**