

415U-1-Cx Condor Wireless Battery IO

Installation Guide Cable Gland Wiring

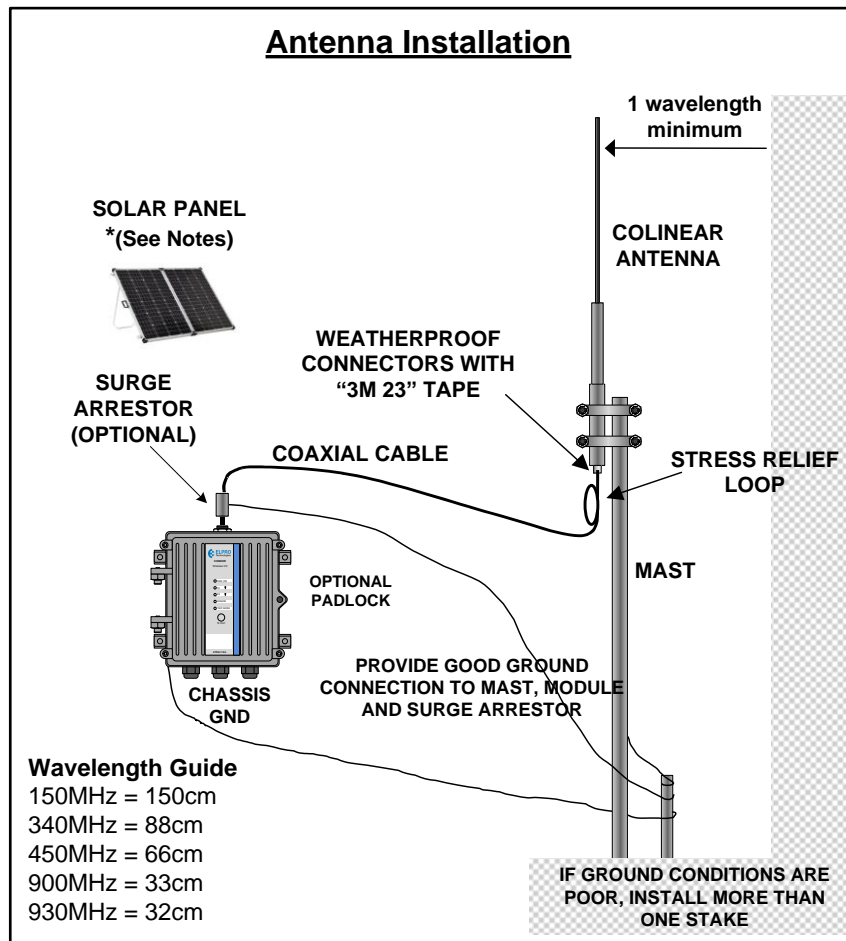

Battery Power Applications:

Units shipped with internal battery option, do not have the battery connected during shipping.

CAUTION - Lithium Primary (LiP non-rechargeable) internal battery: DO NOT connect external voltage directly to battery terminals or to supply/solar terminals as this battery is **NOT rechargeable** and damage may result.

CAUTION - Lithium Iron Phosphate (LFP rechargeable): DO NOT connect external voltage directly to battery terminals as this may result in damage or overheating of battery pack.

To connect the internal battery:

- Remove the battery holder by removing the two Philips screws and battery bracket.
- Locate the battery connector located at the top right of battery as shown in picture.
- For internal battery connect the battery by plugging battery cable connector onto the two pin connector on circuit board located to right of internal/external selection link, using correct orientation (keyed).
- The PWR/OK LED green flash every 10 seconds in normal operation. See unit configuration on reverse side of this document.

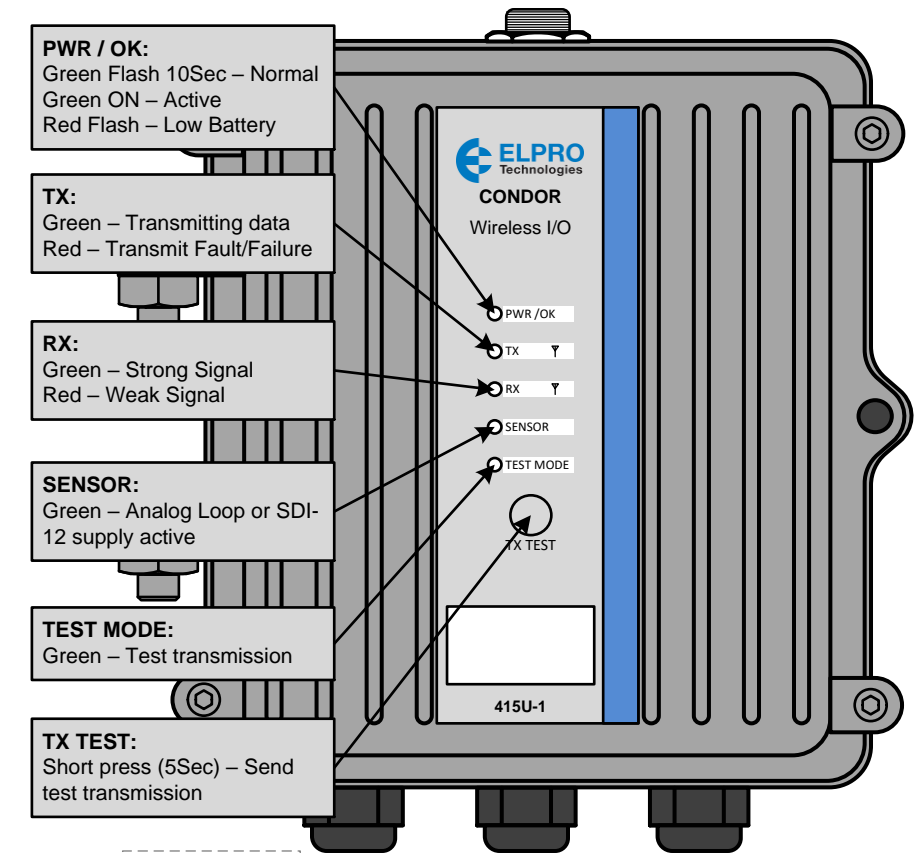
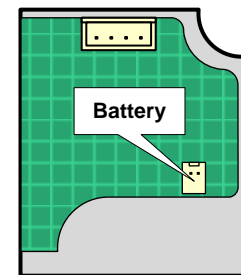

WARNING! EXPLOSION HAZARD

DO NOT DISCONNECT WHILE CIRCUIT IS LIVE UNLESS AREA IS KNOWN TO BE NON-HAZARDOUS

The 415U-1-C4-EX, 415U-1-C3-EX, 415U-1-C1-EX, 415U-1-C91-EX and 415U-1-C92-EX are suitable for use in Class 1, Division 2, Groups A, B, C and D; Tamb -40° C to +70° C or non-hazardous locations only.

This equipment shall be installed in accordance with the requirements specified in Article 820 of the National Electrical Code (NEC), ANSI/NFPA 70-2011. Section 820.40 of the NEC provides guidelines for proper grounding, and in particular specifies that the antenna ground (shield) shall be connected to the grounding system of the building, as close to the point of cable entry as practical.

The earth/ground terminal of this equipment shall be connected to earth ground using green-yellow 18AWG wire or better and secured by M5 screw with star washer to Chassis.

The external power supply installed with this equipment shall be a listed, Class 2 power supply, with rated output between 17 Vdc and 30 Vdc, and minimum 2A

DO NOT connect voltage directly to battery terminals for internal Lithium Iron Phosphate (LFP rechargeable) or Lithium Primary (LiP non-rechargeable) internal battery.

DO NOT connect voltage to solar/external supply terminal for Lithium Primary (LiP non-rechargeable).

CONNECTIONS:
Wiring Entry: IP66 M20 Cable entry Gland (5-13mm)
Terminals: PushIN connection max 0.2 - 1.5mm² wire.

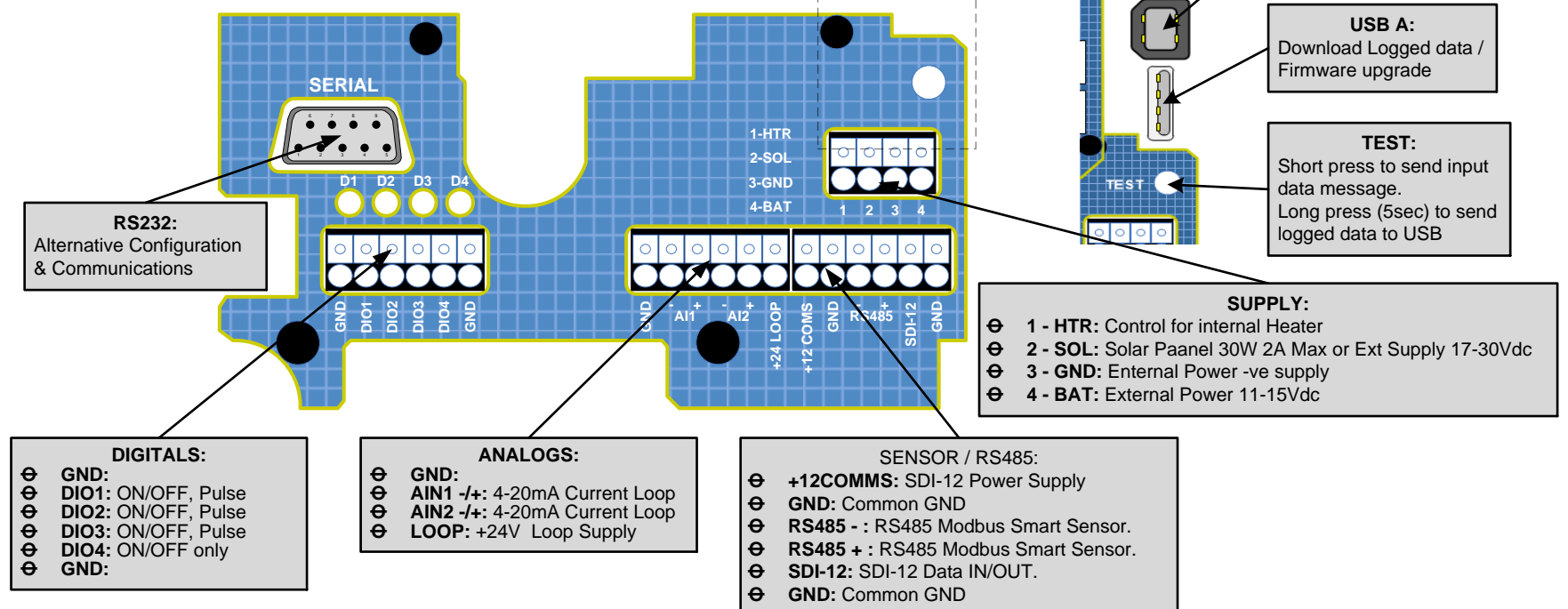

CONFIGURATION

- You will need a terminal program to configure the 415U-1-Cx unit. Putty or TerraTerm are free to download for this purpose.
- Once you have terminal program installed run it and connect the 415U-1-Cx unit to the laptop using a USB type A to type B cable (printer cable)
- Set the terminal serial data rate to 9600,n,8,1.
- Press enter and you should see a login as below:
 - Engineer
 - Technician
- There are two levels of user access. To configure the unit, select menu option 'a' to select Engineer access and enter the default password "Elproeng" and a configuration menu will appear.
- Begin configuration by selecting option 'a' in the menu and entering details as required.
- "Quick Setup" menu option provides a basic configuration with default sensor inputs and recommended update and paralysis to get started.
- Its recommended to use default settings through Quick Setup menu option where possible for best battery life.

Environmental Specification:

Ingress Protection	IP66
Operating Temp ext supply	-40 to 70°C (-40 to 158°F)
LFP rechargeable battery	-10 to 60°C (14 to 140°F)
LiP non-rechargeable battery	-40 to 70°C (-40 to 158°F)
Altitude	2000m
Pollution Degree	4
Internal Humidity	Max 95% non-condensing

POWER SUPPLY

BAT (11-15Vdc): Internal battery if fitted or connect external battery with 5A fast blow fuse.

SOL (17-30Vdc): 5-30W solar panel (**12V Panel**) or an external 24W power supply to power unit or charge internal/external battery (ONLY LFP or SLA).

GND: Power supply system ground

HTR (30Vdc/2A MAX): Low side switch to GND to allow for internal heater to warm battery. ON @ 0°C, OFF @ 2°C

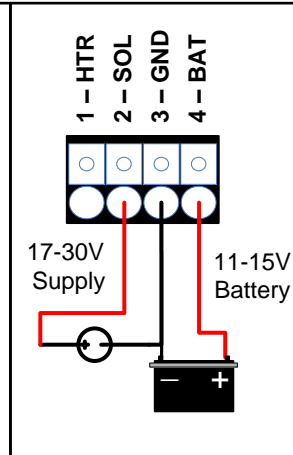

4-20mA ANALOG INPUTS

GND: Analog input ground

AIN1 +/-: Analog input 2/3 wire, source/sink loop powered. 30Vdc max

AIN2 +/-: Analog input 2/3 wire, source/sink loop powered. 30Vdc max

+24 LOOP: 4-20mA Loop power supply. Switched on for warmup plus sample period. 50mA MAX

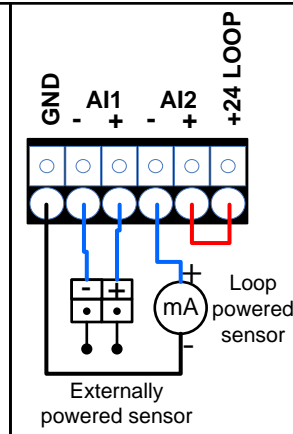

SMART SENSOR

+12COMS: Power supply to SDI-12 sensor (500mA MAX). Switched to power sensor only for warmup time plus sample period.

GND: Smart sensor ground

RS485 +/-: Modbus Smart Sensor connection

SDI-12: Data IN/OUT for sensor

GND: Smart sensor ground

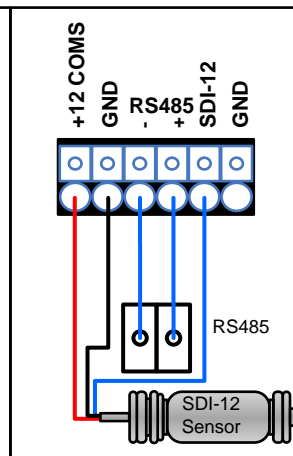

NOTES:

All I/O connections must be SELV
Solar and external power supply/ battery charger:

- 17-30Vdc Supply or internal battery charger input, 2A NEC Certified Class 2
- Solar panel to charge internal/external 12V battery (30W, charge current 2.0A MAX)
- 11-15Vdc battery supply input
- DO NOT connect external supply to BAT terminal with internal battery option connected.

Warning: Solar input is suitable for solar panels rated as 12V nominal only. 24V solar panel can produce open circuit voltages of 44Vdc which will exceed the rated input of the solar regulator and cause damage.

DISCRETE INPUTS

GND: Discrete inputs ground

DIO1: ON/OFF or pulse

DIO2: ON/OFF or pulse

DIO3: ON/OFF or pulse

DIO4: ON/OFF switch only

Note: Discrete input dry contact close to ground

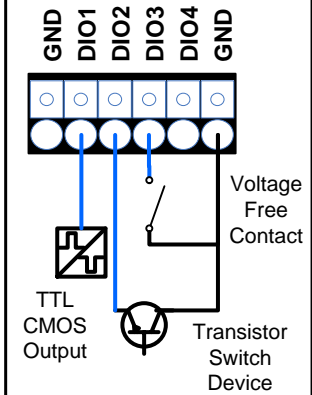

Important Notices

ELPRO products are designed to be used in industrial environments by experienced industrial engineering personnel with adequate knowledge of safety design considerations. ELPRO radio products can be used unprotected license-free radio bands with radio noise and interference. The products are designed to operate in the presence of noise and interference, but in an extreme case radio noise and interference can cause product operation delays or operation failure. Like all industrial electronic products, ELPRO products can fail in a variety of modes due to misuse, age, or malfunction. We recommend that users and designers design systems using design techniques intended to prevent personal injury or damage during product operation and provide failure tolerant systems to prevent personal injury or damage in the event of product failure. Designers must warn users of the equipment or systems if adequate protection against failure has not been included in the system design. Designers must include this Important Notice in operating procedures and system manuals. These products should not be used in non-industrial applications, or life-support systems, without consulting ELPRO first. A radio license is not required in some countries, provided the module is installed using the aerial and equipment configuration described in the Installation Guide. Check with your local distributor for additional information on regulations. Operation of unlicensed equipment is authorized by the radio frequency regulatory authority in your country on a non-protection basis. Although all care is taken in the design of these units, there is no responsibility taken for sources of external interference. Systems should be designed to be tolerant of these operational delays. To avoid the risk of electrocution, the aerial, aerial cable, data/IO cables and all terminals of the module should be electrically protected. To provide maximum surge and lightning protection, the module should be connected to a suitable ground and the aerial, aerial cable, IO, data cables and the module should be installed as recommended in the Installation Guide. To avoid accidents during maintenance or adjustment of remotely controlled equipment, all equipment should be first disconnected from the module during these adjustments. Equipment should carry clear markings to indicate remote or automatic operation. For example: "This equipment is remotely controlled and may start without warning. Isolate at the switchboard before attempting adjustments." The equipment operates unlicensed radio frequencies, proprietary protocols to communicate over the radio, cyber security features and encryption. Nevertheless, if your system is not adequately secured, third parties may be able to gain access to your data or gain control of your equipment via the radio link. Before deploying a system, make sure that you have carefully considered the security aspects of your installation and read the user documentation.

Proper Use

Any unauthorized modifications to or use of this equipment outside its specified mechanical, electrical, or other operating limits may cause personal injury and/or property damage, including damage to the equipment. Any such unauthorized modifications: (1) constitute "misuse" and/or "negligence" within the meaning of the product warranty, thereby excluding warranty coverage for any resulting damage; and (2) invalidate product certifications or listings.